

SEQUÊNCIA DE MONTAGEM DAS PEÇAS

MOUNTING SEQUENCE
SECUENCIA DE MONTAJE

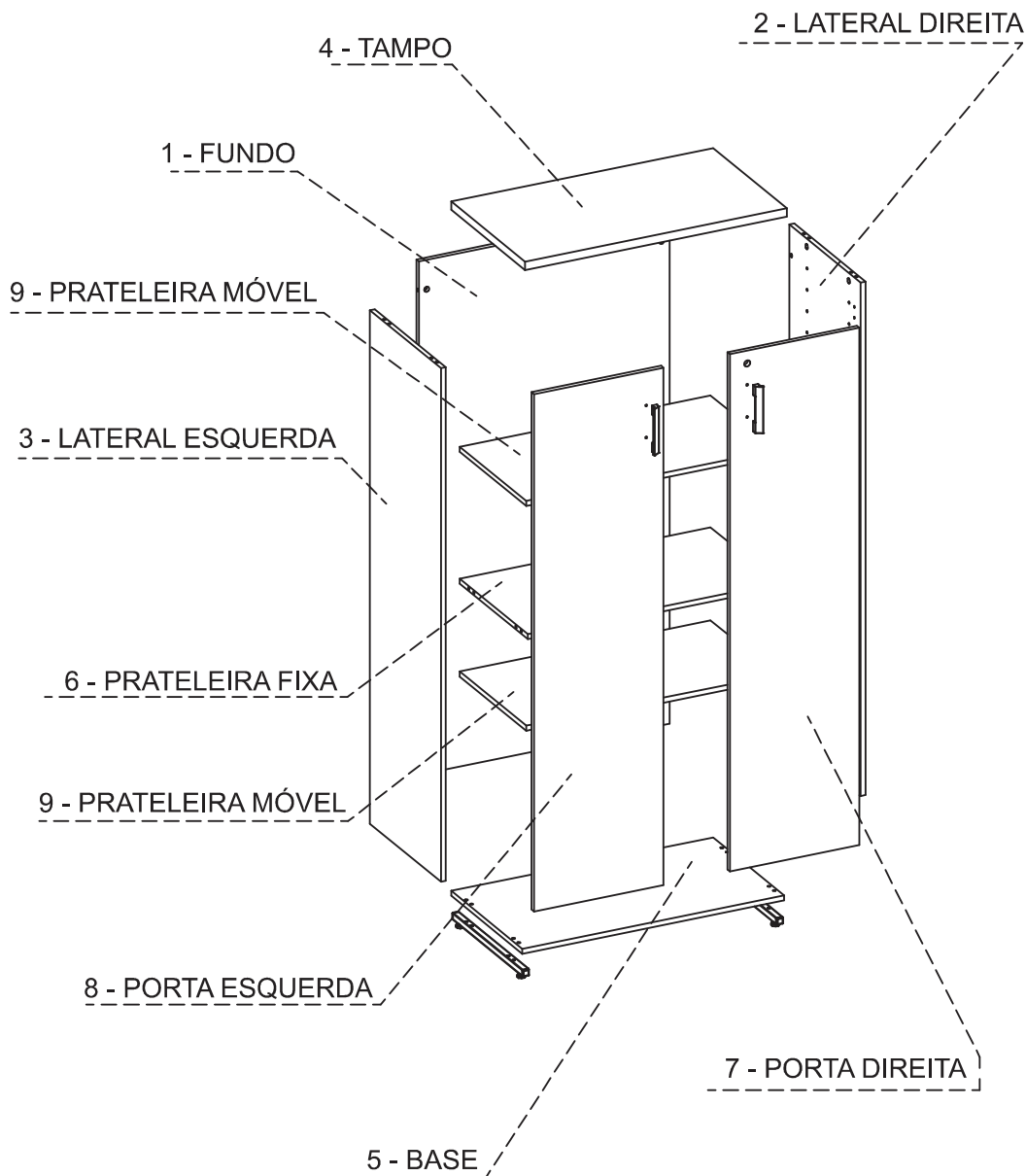

MANUAL DE MONTAGEM

ASSEMBLY INSTRUCTION
INSTRUCCIONES DE MONTAJE

LINHA: PRIMA

PRODUTO: ARMÁRIO ALTO FECHADO

PRODUCT
PRODUCTOS









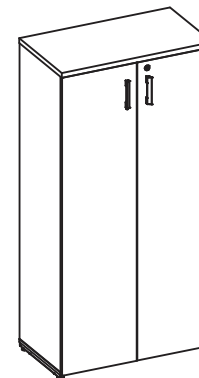







CÓDIGOS

CODES
CÓDIGOS

▶ 410005014

▶ 410005015



P	4	10150038	
O	4	10110147	
N	1	11030015	
M	6	11010010	
L	12	10140002	
K	14	10130014	
J	14	10120003	
I	14	10120001	
H	4	10030246	
G	32	10010546	
F	8	06800101	
E	18	06602015	
D	2	06103012	
C	1	045200048	
B	1	045200046	
A	2	045200015	
Item	Qtd	Cod.	Imagem

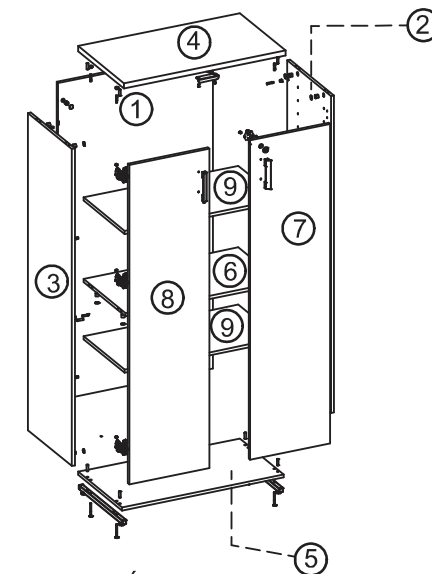

9- PRATELEIRA MÓVEL
8- PORTA ESQUERDA
7- PORTA DIREITA
6- PRATELEIRA FIXA
5- BASE
4- TAMPO
3- LATERAL ESQUERDA
2- LATERAL DIREITA
1- FUNDO



